

# SERVICE INSTRUCTIONS FOR "P-CNN/H" & "P-KNN/H" SINGLE PRESSURE COMPENSATOR WITH SOFT START & HORSEPOWER LIMITER FOR PVG 048/065/075 PUMP, F1 SERIES CONTROL

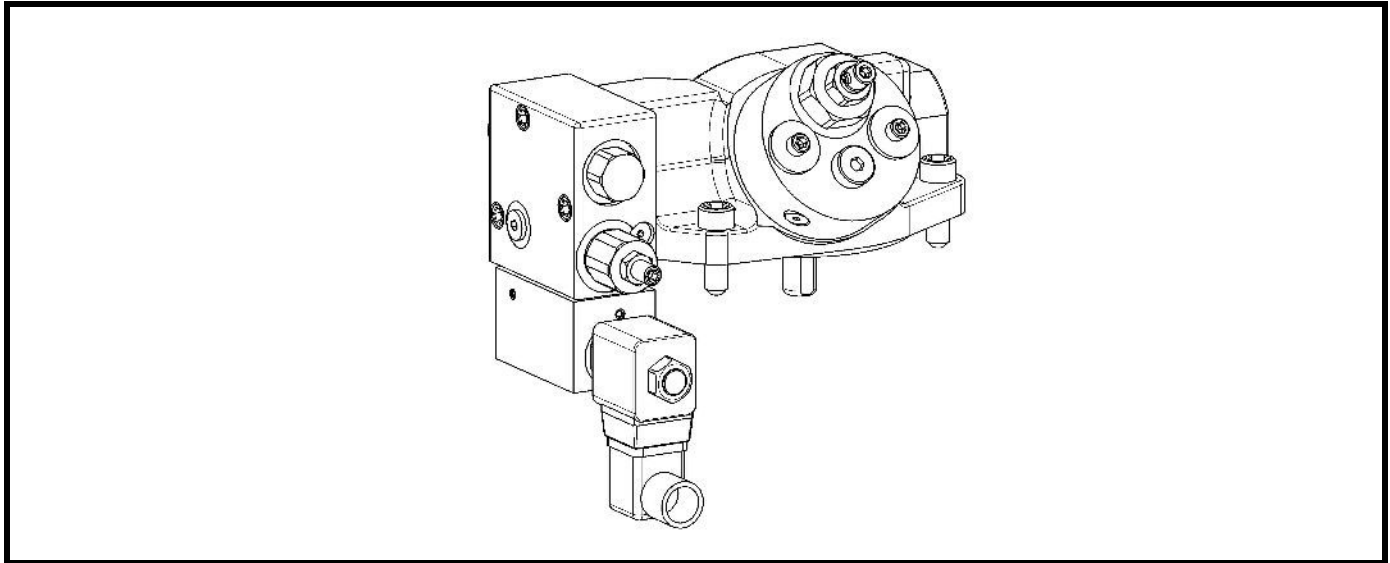

Figure 1. Typical Oilgear Type "P-CNN/H" & "P-KNN/H" Single Pressure - Soft Start with Horsepower Limiter, Control for "PVG" 048/065/075 Pumps

## PURPOSE OF INSTRUCTIONS

These instructions will simplify the installation, operation, troubleshooting and maintenance of Oilgear type "P-CNN/H" & "P-KNN/H" Single Pressure - Soft Start with Horsepower Limiter.

This material will inform you about the basic construction, principle of operation and service parts listings. Some controls may be modified for specific applications from those described in this bulletin and other changes may be made without notice.

## REFERENCE MATERIAL

Fluid Recommendations .....	Bulletin 90000
Contamination Evaluation Guide.....	Bulletin 90004
Filtration Recommendations .....	Bulletin 90007
Piping Information .....	Bulletin 90011
Installation of Vertically Mounted Axial Piston Units .....	Bulletin 90014
PVG Pumps - 048/065/075 Service Instructions .....	Bulletin 947023
PVG Open Loop Pumps, Sales .....	Bulletin 47019-K

## PVG 048/065/075 PUMP INSTALLATIONS

Horsepower Limiter, Single Pressure - Soft Start "P-CNN/H" & "P-KNN/H"....	Data Sheet 47618
Rear Ported Basic Pump, Installation.....	Data Sheet 47952
Side Ported Basic Pump, Installation.....	Data Sheet 47953
Through Shaft Basic Pump, Installation .....	Data Sheet 47954
Gear Pump, Installation.....	Data Sheet 47945
Dual Pump Adapters, Installation.....	Data Sheet 47958

**THE OILGEAR COMPANY**  
905 South Downing Street  
Fremont, NE USA 68025  
www.oilgear.com

## Safety First

Read and understand this entire instruction sheet before repairing or adjusting your Oilgear product.

Those who use and maintain this equipment must be thoroughly trained and familiar with the product. If incorrectly used or maintained, this product and its equipment can cause severe injury.

### SAFETY SYMBOLS

The following signal words are used in this instruction sheet to identify areas of concern where your safety may be involved. Carefully read the text and observe any instructions provided to ensure your safety.

#### **DANGER**

**THIS SIGNAL WORD INDICATES AN IMMEDIATELY HAZARDOUS SITUATION WHICH, IF NOT AVOIDED, WILL RESULT IN DEATH OR SERIOUS INJURY.**

#### **WARNING**

This signal word indicates a potentially hazardous situation which, if not avoided, could result in death or serious injury.

#### **CAUTION**

This signal word indicates that a potentially hazardous situation exists which, if not avoided, may result in damage to equipment or minor personal injury.

#### **NOTE**

*While not directly relevant to the topic being discussed, the NOTE is used to emphasize information provided, or provide additional information which may be of benefit.*

#### **WARNING**

This service information is designed for the maintenance of your Oilgear product. It contains the information on the correct procedures determined by Oilgear for the safe manner of servicing. Always keep this instruction sheet in a location where it is readily available for the persons who use and maintain the product. Additional copies of this instruction sheet are available through the Oilgear website: [www.oilgear.com](http://www.oilgear.com). Please contact us if you have any questions regarding the information in this instruction bulletin.

#### **NOTE**

*The cleanliness of working on this pump control or the hydraulic system is extremely important to the safety and reliability of the pump and the system. Always make sure the fittings are clean on the outside before removing them from their connections, are capped and plugged when removed, and are placed in a clean rag or container until they are reinstalled.*

#### **WARNING**

Some service operations may require special tools or equipment. If you require information on these items, please contact Oilgear before attempting these repairs and service operations.

#### **WARNING**

Read, understand and follow the safety guidelines, dangers and warnings contained in this instruction sheet to promote reliable operation and prevent serious personal injury.

#### **WARNING**

DO NOT attempt to service this machinery in an environment where safety regulations are not established and in place.

#### **WARNING**

DO NOT operate the hydraulic system if a leak is present. Serious injury may result.

#### **WARNING**

Hydraulic systems operate under very high pressure. Hydraulic fluid escaping from a pressurized system can penetrate unprotected body tissue. DO NOT inspect for hydraulic leaks with bare hands or other exposed body parts. As a minimum, wear leather gloves prior to inspecting for leaks and use cardboard or wood. If leaks are present, relieve pressure and allow system to cool prior to servicing. If injured by escaping hydraulic oil, contact a physician immediately. Serious complications may arise if not treated immediately. If you have questions regarding inspecting for hydraulic leaks, please contact Oilgear prior to servicing.

**⚠ WARNING**

Hydraulic hoses and tubing must be inspected on a daily basis for leaks, cuts, abrasions, damage and improper clearance along any mounting frame for hidden damage before the unit is put into service. Replace damaged hoses or hoses you suspect are damaged before the system is returned to service! Hoses must be replaced every 2 years. Failure to properly inspect and maintain the system may result in serious injury.

**⚠ WARNING**

Hydraulic systems are hot. **DO NOT TOUCH!** Serious personal injury may result from hot oil. When you have completed working on the hydraulic system, thoroughly clean any spilled oil from the equipment. Do not spill any hydraulic fluids on the ground. Clean any hydraulic fluids from your skin as soon as you have completed maintenance and repairs. Dispose of used oil and system filters as required by law.

**⚠ WARNING**

Use hoses, fittings and adapters with the correct SAE rating when replacing hoses to prevent possible serious injury. Always replace hoses, fittings and adapters with replacements that have a proper, suitable, working pressure rating. Replacement hoses must be of the correct length and must comply with the hose manufacturer's and Oilgear's installation guidelines and recommendations.

**⚠ WARNING**

Hydraulic hoses have the SAE ratings marked on the hose to assist you in selecting the correct hose. The same manufacturer must supply any replacement hydraulic hoses and fitting assemblies. As an example: Brand "X" hose and brand "Y" fitting will not normally be compatible. No "Twist" is allowed in the hydraulic hoses. "Twist" may result in premature hose failure. This can cause serious injury. Please contact Oilgear for assistance when required.

**⚠ WARNING**

Hydraulic cylinders can be holding a function in a certain position when the pump is off. An example of this is a function being held in the lift or partial lift position by the cylinders. If a hydraulic line is removed or the hydraulic circuits or controls are being worked on, gravity may allow the function being held in position to drop. All workers and personnel must remain clear of these areas when working on or operating the hydraulic system. Block and secure all devices and functions which apply before beginning work or operation. Failure to comply with this can result in serious injury or death.

**⚠ WARNING**

Any hydraulic pipe which is replaced must conform to SAE J1065 specifications. If incorrect hydraulic pipe is installed, the hydraulic system may fail, causing serious injury. Damaged or leaking fittings, pipes or hoses must be replaced before the system is returned to service.

**⚠ WARNING**

**DO NOT** heat hydraulic pipe. The carbon content of this steel tube is such that if heated for bending, and either water or air quenched, the pipe may lose its ductility and thereby be subject to failure under high pressure conditions. Serious injury can result. Damaged or leaking pipes must be replaced before the system is returned to service. Please contact Oilgear if you require assistance or have questions.

**⚠ WARNING**

All hydraulic pressure must be relieved from the hydraulic system prior to removing any components from the system. To relieve the hydraulic pressure from the hydraulic system, turn off the motor and operate the control panel with the key in the ON position. Failure to comply can result in serious injury. If you have any questions concerning relieving the hydraulic pressure from the system, please contact Oilgear.

### **WARNING**

Hydraulic components can be heavy. Use caution while lifting these components. Serious personal injury can be avoided with proper handling of the components.

### **WARNING**

Please contact Oilgear if you require assistance. When performing hydraulic test procedures, use the proper hydraulic gauges. Installing an incorrect test gauge could result in serious injury if the gauge fails. Use properly rated hydraulic hoses to allow the test gauge to be read away from moving parts and functions.

### **WARNING**

Increasing hydraulic pressure beyond the recommendations may result in serious damage to the pump and system or serious personal injury, and may void the Oilgear Warranty. If you have questions concerning hydraulic pressures or testing procedures, please contact Oilgear before attempting the test procedures or making adjustments.

### **WARNING**

An Oilgear pump or pump control must not be modified in any way without authorization from Oilgear. Modifications may not comply with safety standards, including ANSI safety standards, and may result in serious personal injury. Please contact Oilgear if you require assistance.

### **WARNING**

DO NOT enter under hydraulic-supported equipment unless it is fully supported or blocked. Failure to follow this procedure can result in serious injury or death.

### **WARNING**

Any Oilgear pump safety decals must be replaced anytime they are damaged, missing or cannot be read clearly. Failure to have proper decals in place can result in serious injury or death. (If you require safety decals, please contact Oilgear for replacement safety decals, at no charge.)

### **WARNING**

Be sure everyone is clear of the area around the hydraulic system before operating after servicing. Remain attentive at all times when operating to check your work until you are completely sure it is safe to return to service. Failure to heed this warning may result in serious personal injury or death.

### **WARNING**

Wear the proper protective clothing when operating, servicing or maintaining the hydraulic system or the Oilgear pump. Wear the correct protective gear, safety glasses, gloves and safety shoes. Serious injury can result without proper protective gear.

### **WARNING**

Make sure to keep hands, feet and other parts of your body clear of revolving or moving parts. Failure to comply can cause serious injury.

### **WARNING**

DO NOT wear watches, rings or jewelry while working with electrical and mechanical equipment. These items can be hazardous and can cause serious and painful injuries if they come into contact with electrical wires, moving parts or hydraulic equipment.

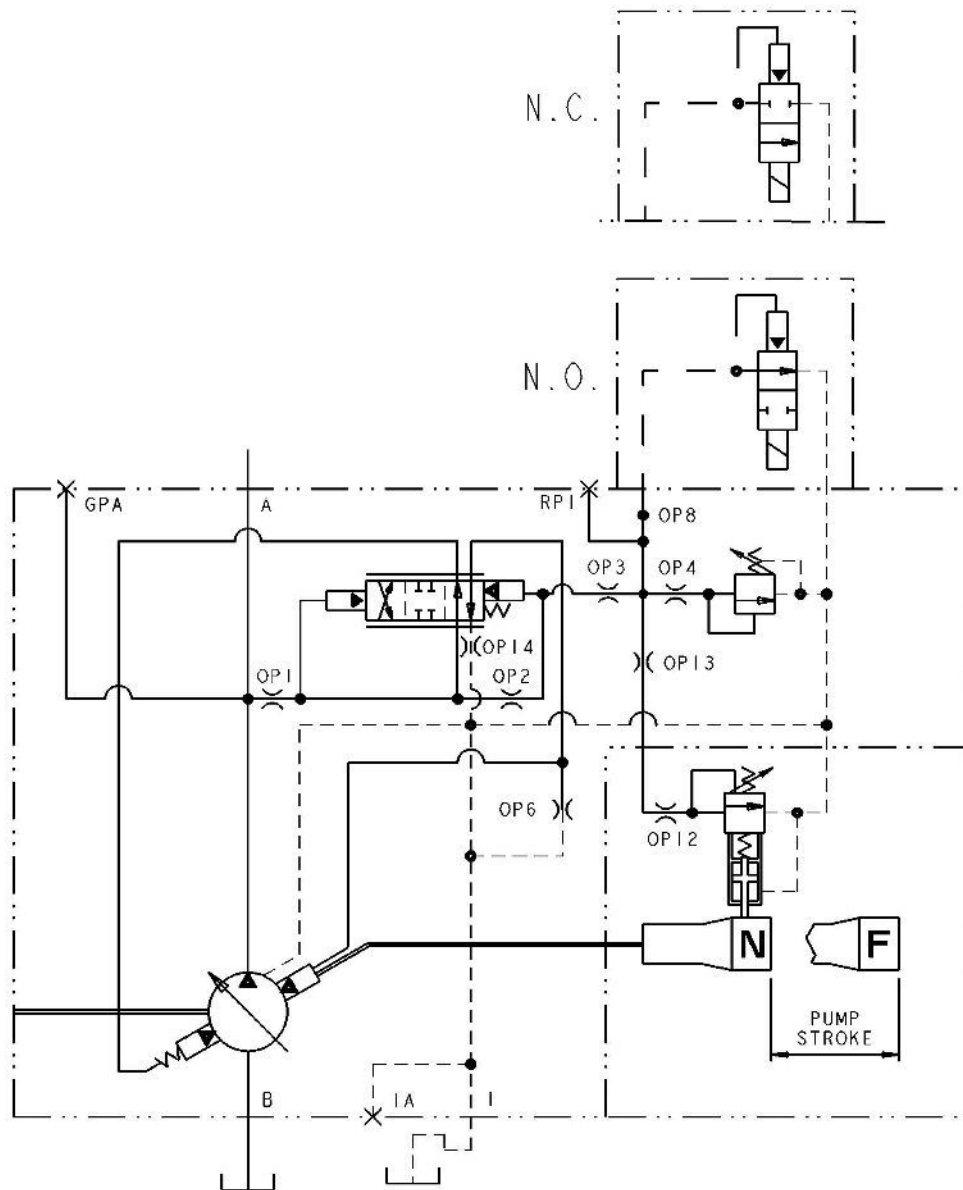

Figure 2. ASA Diagram for "P-CNN/H" & "P-KNN/H" Control Shown with Typical Pump

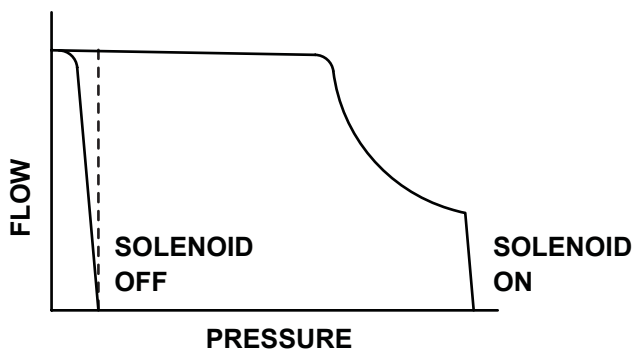

Figure 3a. Curve Indicating Flow Versus Pressure for "P-CNN/H" Type Control

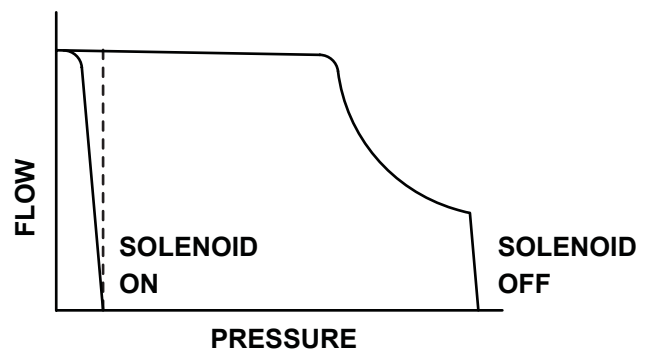

Figure 3b. Curve Indicating Flow Versus Pressure for "P-KNN/H" Type Control

## TROUBLESHOOTING

PROBLEM	CAUSES	REMEDY
<b>Unresponsive or Unstable Control</b>	Swashblock bearing surface and/or saddle bearings worn or damaged	Refer to 947023 Pump Service Instructions.
	Guide plate damaged	
	Fluid is contaminated	Inspect and clean if necessary. Refer to Filtration Recommendations Bulletin 90007.
	Contamination trapped between control piston and bore not allowing piston to move smoothly	Inspect and clean if necessary. Replace damaged parts.
	Contamination trapped between control spool and bore not allowing spool to move smoothly	
	Insufficient control flow	Increase size of control orifice "OP 6.
	Worn or damaged pilot relief seat and/or poppet	Inspect and replace if necessary.
	Faulty remote function circuit	
Hydraulic line between remote function and pump port RP1 is incorrect	Change hydraulic line.	
<b>Insufficient Outlet Volume</b>	Swashblock bearing surface and/or saddle bearings worn or damaged	Refer to 947023 Pump Service Instructions.
	Guide plate damaged	
	Low input drive speed	
	Worn cylinder barrel and/or valve plate mating surfaces	
	Failed drive shaft	
	Worn or damaged piston shoes and/or swashblock	
	Worn pistons and/or piston bores	Adjust maximum volume stop CCW to increase flow.
	Maximum volume stop adjusted incorrectly	
	Pressure compensator is set too close to operating pressure	Adjust pressure compensator CW to increase pressure.
	Improper horsepower setting	Requires factory adjustment
	Worn or damaged horsepower valve	Requires factory service
	Control piston stuck off stroke	Inspect and replace if necessary.
Faulty remote function circuit		
<b>Unable to Develop Full Pressure</b>	System requires more flow than available	Check system for leaks or open functions.
	Pressure compensator adjustment not set correctly	Adjust pressure compensator CW to increase pressure.
	Improper horsepower setting	Requires factory adjustment
	Worn or damaged horsepower valve	Requires factory service
	Contamination in control spool	Inspect and clean if necessary.
	Worn or damaged pilot relief seat and/or poppet	Inspect and replace if necessary.
	Pressure selector valve seat and/or poppet worn or damaged	
	Pressure selector valve solenoid damaged	
Control piston stuck off stroke		
Faulty remote function circuit		

## TROUBLESHOOTING

PROBLEM	CAUSES	REMEDY
<b>Excessive Pressure</b>	Swashblock bearing surface and/or saddle bearings worn or damaged	Refer to 947023 Pump Service Instructions.
	Guide plate damaged	
	Pressure compensator adjustment not set correctly	Adjust pressure compensator CCW to decrease pressure.
	Improper horsepower setting	Requires factory adjustment
	Contamination in "OP 3", "OP 4", "OP 12" or "OP 13"	Inspect and clean if necessary.
	Contamination in pressure selector valve seat	
	Restricted passage between outlet and control spool	
	Contamination trapped between control piston and bore not allowing piston to move smoothly	Inspect and clean if necessary. Replace damaged parts.
	Contamination trapped between control spool and bore not allowing spool to move smoothly	
	Faulty remote function circuit	Inspect and replace if necessary.



## GENERAL

Operation for a typical pump is described. Section diagrams are a representation of typical pumps with "P-CNN/H" & "P-KNN/H" control.

Functionally, the swashblock (and resultant delivery) is positioned by two opposite (acting) control pistons.

See control parts drawing for actual configuration and location of part assemblies, orifices, connections and ports.

## PRINCIPLE OF OPERATION

### STARTING

The bias control piston spring (329) positions the control and connected pump swashblock so that the pump will deliver maximum volume to raise pressure in the system.

### RAISING PRESSURE (LOADING)

Pump delivery (and resultant pressure) is fed back to the control through Port "OP 1." The pressure compensating spool (305) is held in position by a pilot control valve spring (328). Flow (and resultant pressure) is transmitted through the pressure compensating spool (305) to the area behind the bias control piston and through orifice Port "OP 2."

Pressure acting on either end of the pilot control valve is equal. The spool is balanced and held in position by the pilot control valve spring (328). Flow (and resultant pressure) is also transmitted through Port "OP 3" and Port "OP 4" to the adjustable control relief valve (310), through Port "OP 8" to the pilot vent valve and through Ports "OP 12" and "OP 13" to the horsepower control valve, which blocks further flow in the control (and pressure transmittal).



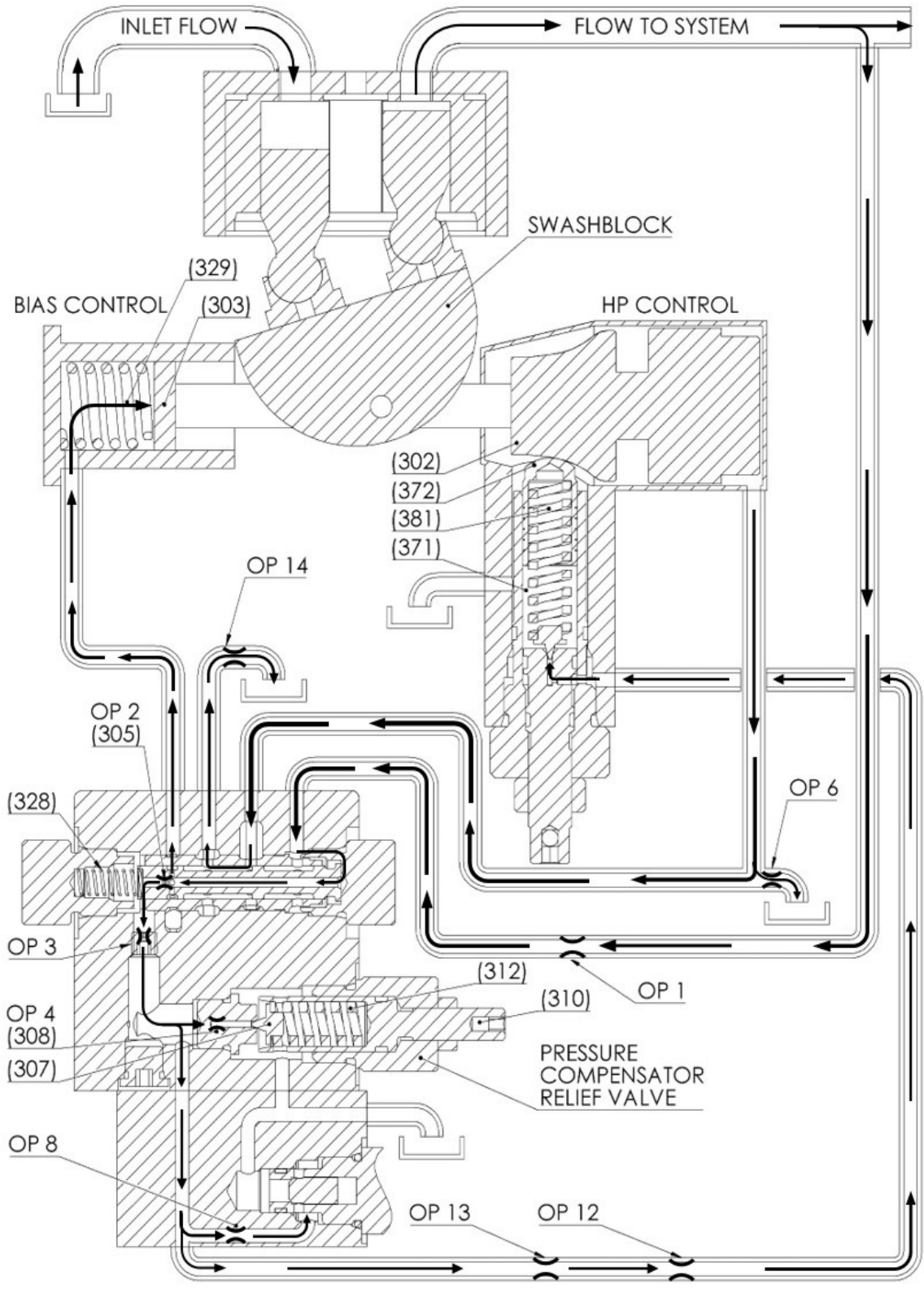

**Figure 4. Raising Pressure (Loading)**

---

## **COMPENSATING PRESSURE (UNLOADING) AT MINIMUM PRESSURE WITH PILOT VENT VALVE OPEN TO PASS FLOW**

With vent valve open allowing flow through drain line to pump case and case drain, pressure is reduced on the spring end of the pressure compensating spool **(305)**.

Flow through “OP 2” reduces pressure on the spring end of the pressure compensating spool **(305)**. There is still full pressure on the other end of the pressure compensating spool. This differential pressure forces the pressure compensating spool **(305)** to shift and compress the control valve spring **(328)**. The pressure compensating spool now allows pump delivery (and resultant pressure) to flow to the unloading control piston. The pressure compensating spool simultaneously drains the fluid from behind the bias control piston.

The control piston now moves the control pin and shifts the swashblock to a position towards neutral, where the pump delivers sufficient volume to maintain minimum pressure.

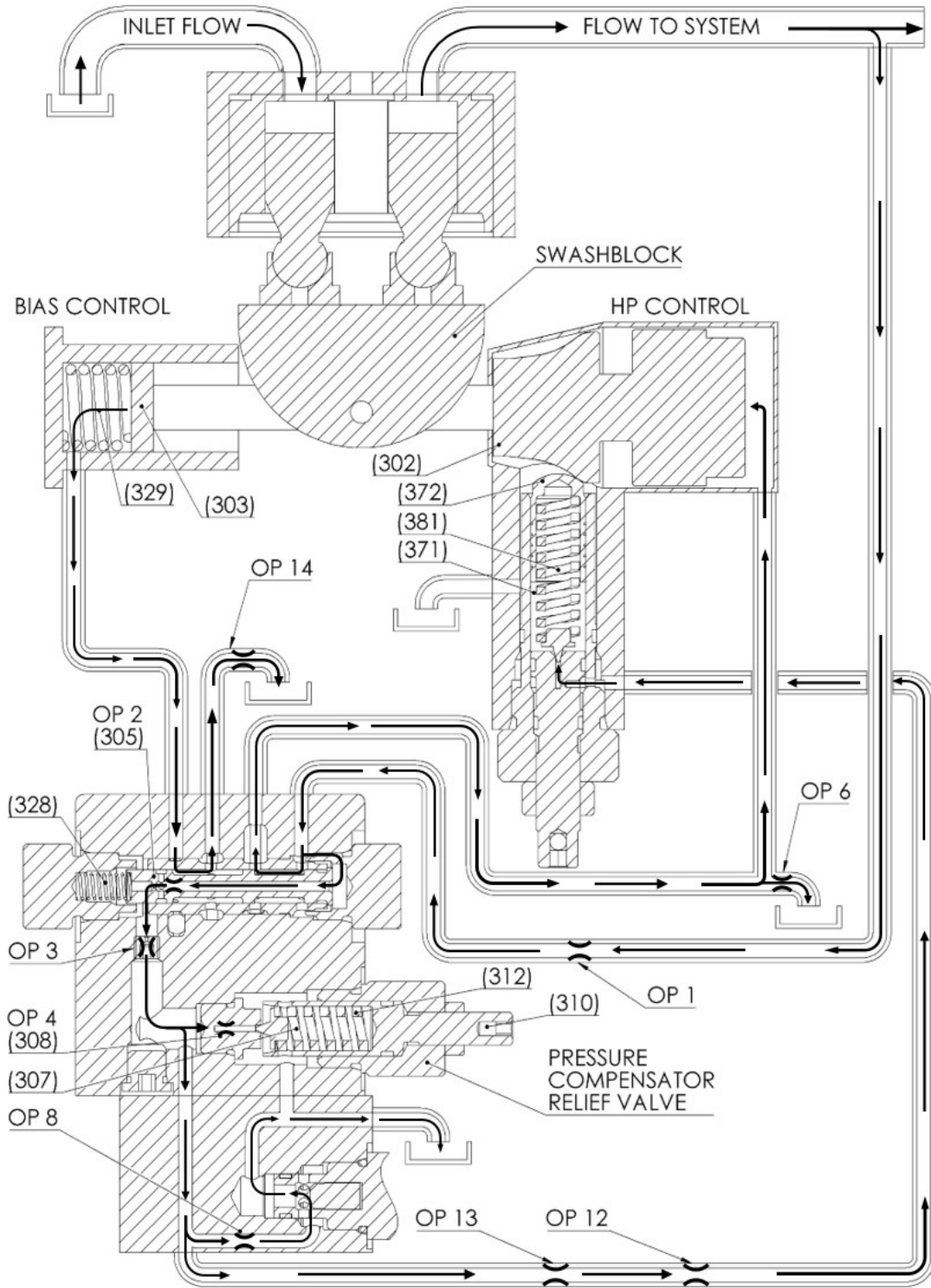

**Figure 5. Compensating Pressure (Unloading) at Minimum Pressure with Pilot Vent Valve Open to Pass Flow**

---

## **COMPENSATING PRESSURE (UNLOADING) AT HIGHER PRESSURE WITH PILOT VENT VALVE CLOSED TO BLOCK FLOW**

When pressure on the relief valve poppet **(307)** exceeds the presetting of the relief valve screw **(310)**: Set by turning the valve screw in or out, which sets the force of the relief valve spring **(312)**. The relief valve poppet **(307)** moves off seat **(308)** and allows flow through the valve, and through drain line to pump case and case drain. Pressure is reduced on the spring end of the pressure compensating spool **(305)**.

Flow through “OP 2” reduces pressure on the spring end of the pressure compensating spool **(305)**. There is still full pressure on the other end of the pressure compensating spool. This differential pressure forces the pressure compensating spool **(305)** to shift and compress the control valve spring **(328)**. The pressure compensating spool now allows pump delivery (and resultant pressure) to flow to the unloading control piston. The pressure compensating spool simultaneously drains the fluid from behind the bias control piston.

The control piston now moves the control pin and shifts the swashblock to a position towards neutral, where the pump delivers sufficient volume to maintain system pressure as regulated by the control relief valve **(310)**.

## **HOLDING PRESSURE**

If the system pressure drops below preset compensating pressure, the relief valve poppet **(307)** seats and forces on the pressure compensating spool **(305)** are balanced, the pilot control valve spring **(328)** returns the spool to the original position **(Figure 4)**, swashblock position shifts, and the pump increases delivery until the relief valve screw **(310)** preset pressure is reached again.

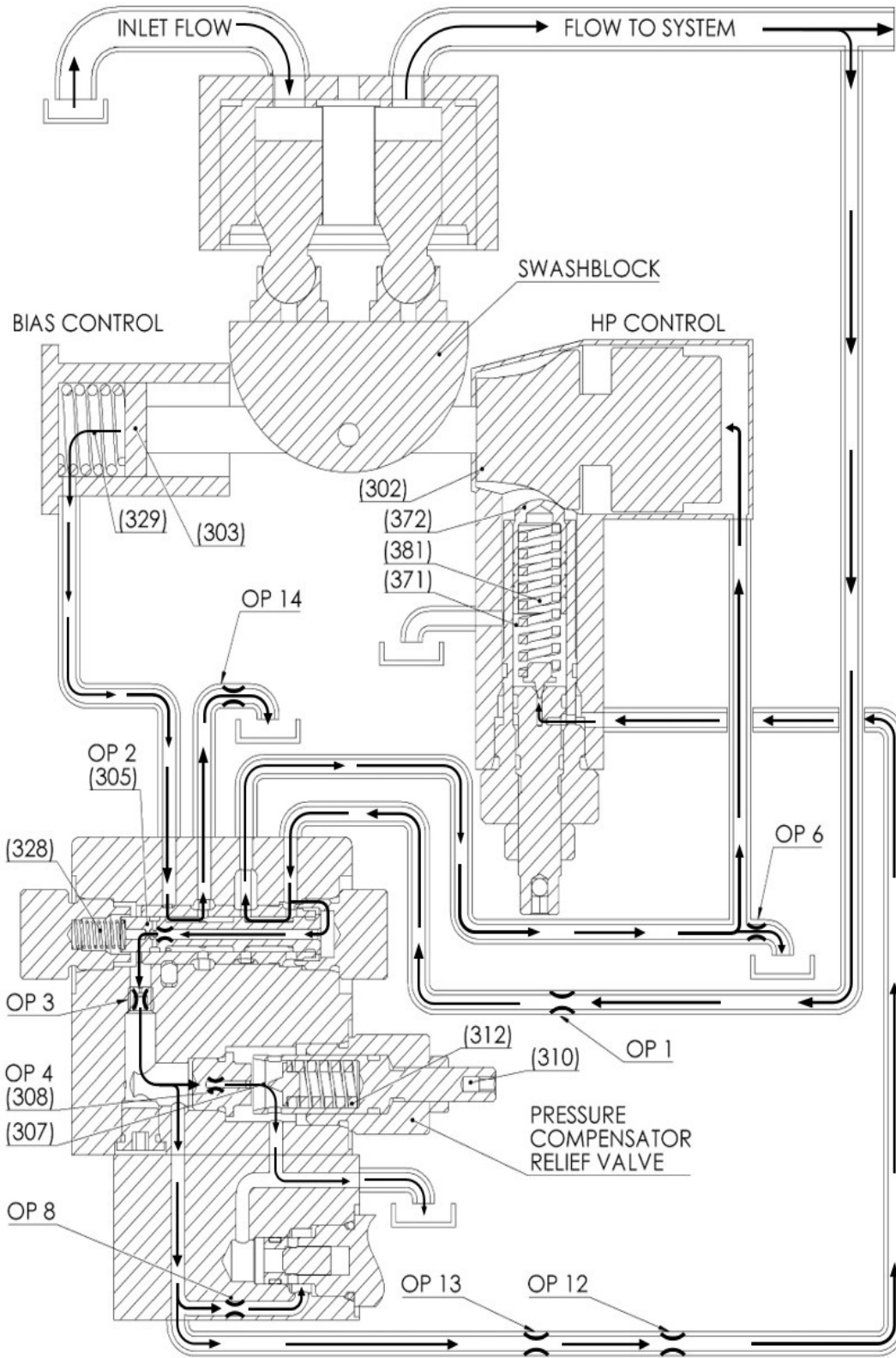

**Figure 6. Compensating Pressure (Unloading) at Higher Pressure with Pilot Vent Valve Closed to Block Flow**



---

## **COMPENSATING PRESSURE (UNLOADING) - HORSEPOWER LIMITER ACTIVE**

A horsepower limiter is typically used when limited horsepower is available, and high volume at low pressure and low volume at high pressure are required.

Constant horsepower is related to flow and pressure. The flow is proportional to the swashblock angle. For a given swashblock angle, the cam on the control piston **(302)** adjusts the force on the horsepower valve through the cam follower **(372)** compressing spring **(381)**.

When the system pressure on the poppet **(371)** reaches the spring **(381)** force, the valve opens and flow across the valve generates a pressure drop across "OP 2." The unbalance of forces across the pressure compensating spool **(305)** shifts the spool, porting system pressure to the unloading control and draining the bias control.

The control piston moves until a control piston stroke is attained at the system pressure for constant horsepower setting of the control.

With decrease of system pressure, the horsepower valve poppet **(371)** reseats, blocking flow to drain. The compensating spool **(305)** will shift, causing the control piston to increase pump flow until constant horsepower is attained.

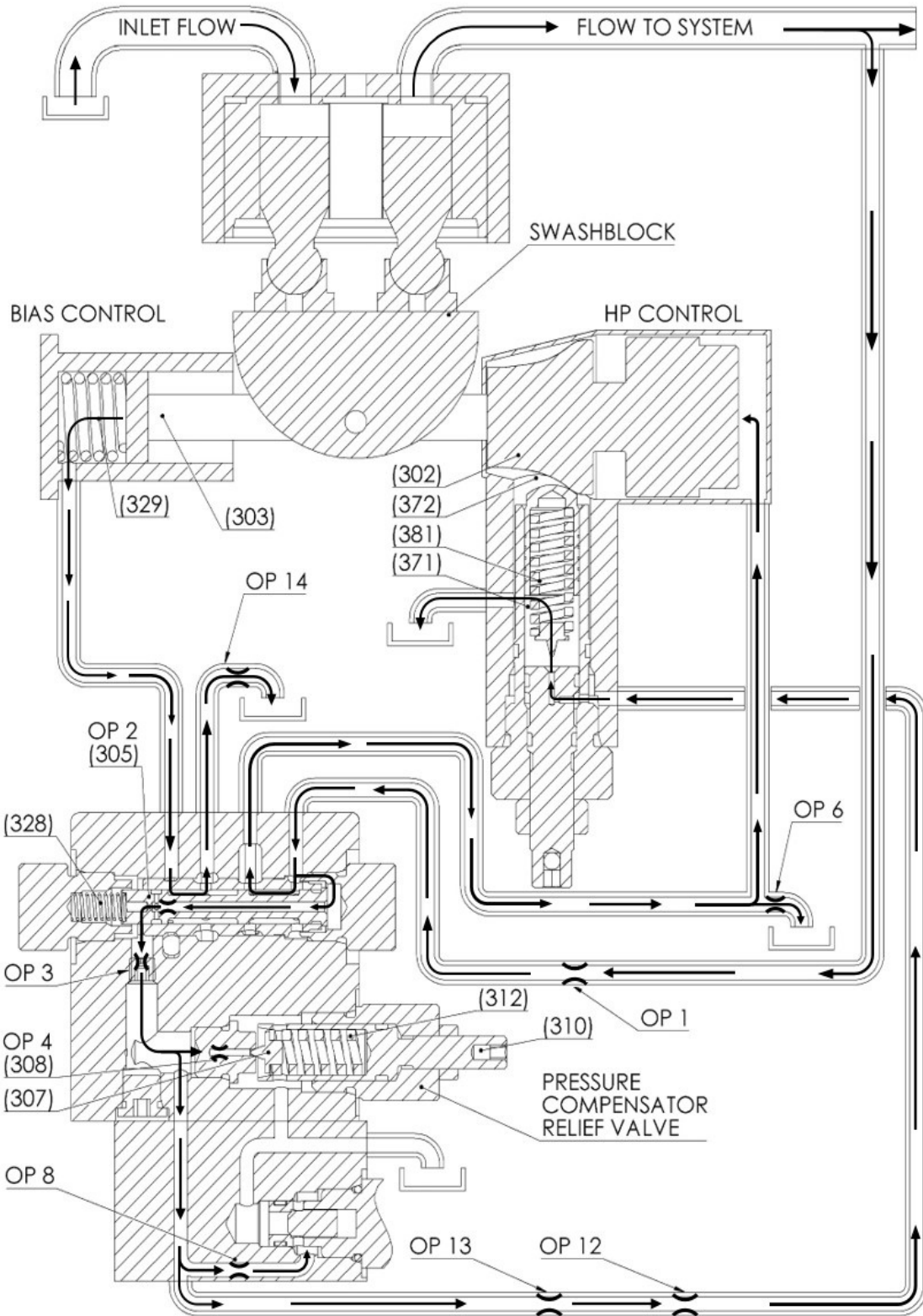

**Figure 7. Compensating Pressure (Unloading) - Horsepower Limiter Active**



## ORIFICE FUNCTIONS

Orifice Number	Decreasing orifice diameter will result in: (increasing diameter will do the opposite)
"OP 1"	Do not decrease to less than .125"
"OP 2"	Do not change
"OP 3"	Do not change
"OP 4"	Do not change
"OP 6"	Decreased stability
"OP 8"	Increased stability
"OP 12"	Do not change
"OP 13"	Do not change
"OP 14"	Slowing down of "on stroke" time, do not decrease to less than .081"

"OP 1" .125 Orifice

"OP 2" Integral to spool, item 305

"OP 4" Integral to seat, item 308

"OP 6" .062 Orifice

"OP 8" Orifice not used (standard)

"OP 14" .081 Orifice Integral to End Cap, item 304

## SCREW AND PLUG TORQUES FOR PVG-048/065/075 "P-CNN/H" & "P-KNN/H" CONTROL

Fastener or Plug Item Number	Description	Head Type & Size	Tightening Torque
306	SAE #8 Part	7/8" external	50 ft-lbs (68 Nm)
308	SAE #6 Part	7/16" external	200 in-lbs (23 Nm)
309	SAE #10 Part	1" external	80 ft-lbs (108 Nm)
315	5/16-18 SHCS x 2.25" lg	1/4" internal	30 ft-lbs (41 Nm)
316	7/16-14 SHCS x 2.50" lg	3/8" internal	65 ft-lbs (88 Nm)
316A	7/16-14 SHCS x 1.25" lg	3/8" internal	65 ft-lbs (88 Nm)
319	1/16 NPT Plug	5/32" internal	48 in-lbs (5 Nm)
320	SAE #2 Plug	1/8" internal	45 in-lbs (5 Nm)
321	SAE #4 Plug	3/16" internal	120 in-lbs (14 Nm)
322	SAE #8 Part	7/8" external	50 ft-lbs (68 Nm)
323	SAE #12 Plug	9/16" internal	85 ft-lbs (115 Nm)
325	1/16 NPT Plug	5/32" internal	48 in-lbs (5 Nm)
344	1/16 NPT Plug	5/32" internal	48 in-lbs (5 Nm)
347	1/16 NPT Plug	5/32" internal	48 in-lbs (5 Nm)
374	SAE #12 Part	1 1/4" external	85 ft-lbs (115 Nm)
377	1/4-20 SHCS x 1.75" lg	3/16" internal	120 in-lbs (14 Nm)
382	Shoulder Screw .50 dia. 1.00 lg	1/4" internal	30 ft-lbs (41 Nm)
389	SAE #2 Plug	1/8" internal	45 in-lbs (5 Nm)
375A	#10-24 SHCS x 1.50 lg	5/32" internal	57 in-lbs (6 Nm)
391C	SAE #12 Part	1 1/4" external	85 ft-lbs (115 Nm)

## CONTROL O-RING SEALS FOR FOR PVG-048/065/075 "P-CNN/H" & "P-KNN/H" CONTROL

Item Number	Quantity	ARP 568 Size Number / Shore A Durometer	
		Viton or Buna	EPR
313	1	243/70	243/80
314	1	132/70	132/80
330	4	013/90	013/80
331	1	014/90	014/80
332	1	902/90 *	902/80
333	1	906/90	906/80
334	2	908/90	908/80
335	1	910/90	910/80
336	1	912/90 *	912/80
337	1	014/Teflon Back Up Ring	
338	2	904/90 *	904/80
379	1	014/PTFE	014/PTFE
380	1	127/PTFE	127/PTFE
384	1	912/90	912/80
385	1	013/90	013/80
386	1	014/90	014/80
387	1	013/Teflon Back Up Ring	
388	1	014/Teflon Back Up Ring	
390	1	902/90 *	902/80
391	1	018/90	018/80
392	1	018/Teflon Back Up Ring	
370A	1	908/Polyurethane	908/80
	1	Special Polyurethane	012/80
	1	N/A	012/PTFE BU
398A	6	010/90	010/80
394C	1	014/90	014/80
395C	1	912/90	912/80
396C	1	014/Teflon Back Up Ring	

\* Pumps with Buna seals use Viton for all SAE plugs

## PARTS LIST FOR PVG-048/065/075 "P-CNN/H" & "P-KNN/H" CONTROL

Parts used in these assemblies are per Oilgear specifications. Use only Oilgear parts to ensure compatibility with assembly requirements. When ordering replacement parts, be sure to include pump type and serial number, and bulletin number and item number. Specify the type of hydraulic fluid to ensure seal and packing compatibility.

Item Number	Quantity	Description
301	1	Control Housing
302	1	Control Piston
303	1	Bias Piston
304	1	End Cap
305	1	Spool
306	1	Plug
307	1	Poppet
308	1	Seat
309	1	Bonnet
310	1	Adjusting Screw
311	1	Control Pin
312	4	Shim
315	3	Screw
316	1	Screw
316A	2	Screw
318	1	Nut
319	1	Orifice Plug
320	1	Plug
321	2	Plug
322	1	Plug
323	1	Plug
325	1	Orifice Plug
327	1	Spring
328	1	Spring
329	1	Spring

Item Number	Quantity	Description
344	1	Orifice Plug
347	1	Orifice Plug
348	2	Pin
370	1	Housing, HP
371	1	Poppet
372	1	Follower cam
373	1	Adjusting Screw
374	1	Bonnet
375	1	Nut
376	2	Washer
377	2	Screw
378	1	Pin
381	1	Spring
382	1	Screw
389	1	Plug
370A	1	Pilot Valve
371A	1	Module
372A	3	Plug, Permanent
375A	4	Screw
395A	1	Connector, Electric
391C	1	Bonnet
392C	1	Adjusting Screw
393C	1	Nut

**PVG 048/065/075P-CNN/H & P-KNN/H Control Service Kits**

Reference: 520270-202 Ass'y Drwg

**Document Number: 520270-202SK**

**Revision: 0 (02-12-19)**

**Sheet 1 of 1**

Description	Kit Number	Design Series	Items Included (quantity is 1 unless noted)
Control Seal Kit			
Viton Seals	K517107-B01	F1	313, 314, 330(4), 331, 332, 333, 334(2), 335, 336, 337, 338(2), 379, 380,384, 385, 386, 387, 388, 390, 391, 392, 370A, 398A(3), 394C, 395C, 396C
HNBR Seals	K517107-B11		
EPR Seals	K517107-B21		







---

## **AFTER SALES SERVICES**

At Oilgear we build products to last. It is the nature of this type of machinery to require proper maintenance regardless of the care we put into manufacturing. Oilgear has several service programs in place to help you.

### **STAY-ON-STREAM SERVICE**

By signing up for Oilgear's Stay-On-Stream program, you can prepare for problems before they happen. Certain field tests such as fluid testing, slip testing and electronic profile recording comparisons can be performed by our field service people or your own factory trained personnel. These tests can indicate problems before they become "down-time" difficulties.

## **SERVICE SCHOOLS**

Oilgear conducts training to train your maintenance personnel. "General" hydraulic or electronic training is conducted at our Milwaukee, Wisconsin plant on a regular basis. "Custom" training, specifically addressing your particular hydraulic and electro-hydraulic equipment, can be conducted at your facilities.

### **SPARE PARTS AVAILABILITY**

Prepare for your future needs by stocking Oilgear original factory parts. Having the correct parts and necessary skills "in-plant" enables you to minimize "down-time." Oilgear has developed parts kits to cover likely future needs. Oilgear Field Service Technicians are also ready to assist you and your maintenance people in troubleshooting and repairing equipment.

